

EXIT SIGN CUBE 25 m | 35 m | 60 m IP40 | IP54 | IP40 | IP54 | IP54

EXIT SIGN CUBE W25 | W35 | W60

If several routes lead to an emergency exit, an exit sign cube is the right choice. The pictograms of the frameless acrylic glass hood are applied using the screen printing method.

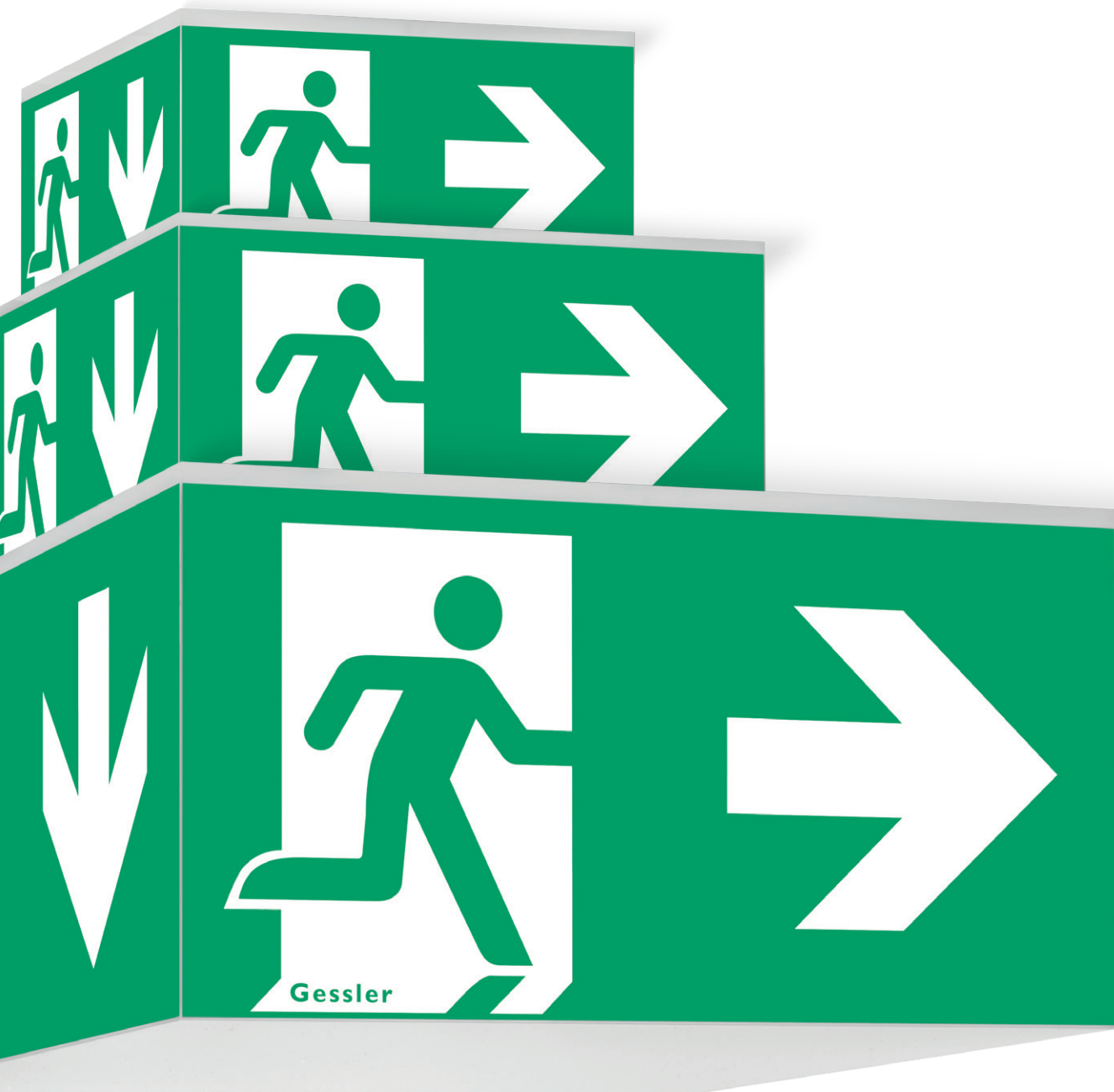

Viewing distance	25 m	
Degree of protection	IP40 IP54	
Class	I	
Enclosure material	Acrylic glass	
Enclosure colour/surface	opal	
Terminal block	3 x 2.5 [□] for through wiring	
Light source	LED	
Ambient temperature	-20° C to +40° C	0° C to +40° C
Connected load (AC/DC)	10.0 VA/6 W	
Supply voltage	230V ± 10 %, 50/60 Hz/176-275 V DC	230V ± 10 %, 50/60 Hz
Rechargeable battery	3.6 V/2.5 Ah (NiCd)	

VERSIONS

1 h with auto-check with BUS check		• •
3 h with auto-check with BUS check		• •
8 h with auto-check with BUS check		• •
without monitoring module	•	
with monitoring module	•	
with DALI monitoring	•	
Cinema version		
Luminous flux in normal mode 10 %		

SPECIAL FEATURE

- Pictograms are attached by the screen printing method (no adhesive film)
- All-round green printing

OPTIONS /ACCESSORIES

- Degree of protection IP54 (except pendant). Deviating dimensions: Increase of approx. 4 mm in the width and 7 mm in the height

W25W WALL MOUNTED

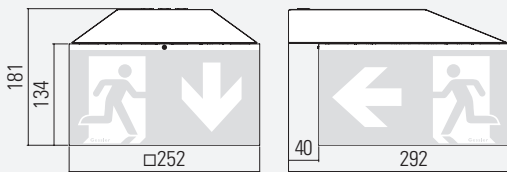

W25D CEILING MOUNTED

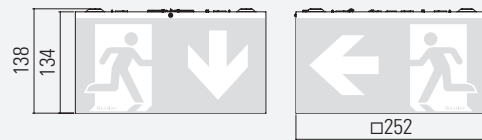

W25P PENDANT

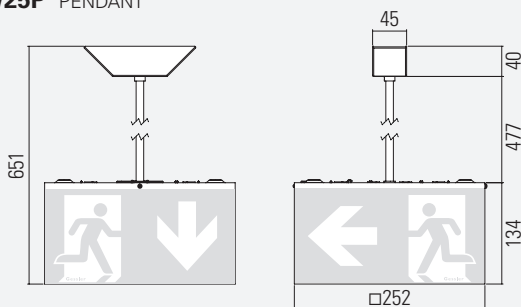

W25S SUSPENDED

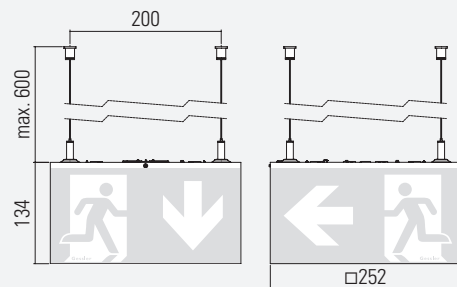

W25Ö EYE INSTALLATION

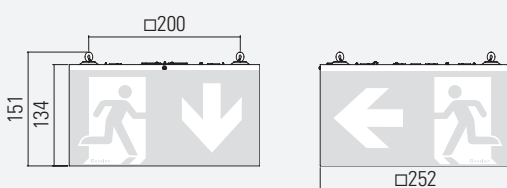

W25

EXIT SIGN CUBE W35

SYSTEM LUMINAIRE

RECHARGEABLE BATTERY LUMINAIRE

Viewing distance	35 m	
Degree of protection	IP40 IP54	
Class	I	
Enclosure material	Acrylic glass	
Enclosure colour/surface	opal	
Terminal block	3 x 2.5 ² for through wiring	
Light source	LED	
Ambient temperature	-20° C to +40° C	0° C to +40° C
Connected load (AC/DC)	10.0 VA/6 W	
Supply voltage	230V ± 10 %, 50/60 Hz / 176-275 V DC	230 V AC
Rechargeable battery	-	3.6 V/2.5 Ah (NiCd)

VERSION

1 h with auto-check BUS check		• •
3 h with auto check BUS check		• •
8 h with auto check BUS check		• •
without monitoring	•	
with monitoring	•	
DALI monitoring	•	
Cinema version		

SPECIAL FEATURE

- Pictograms are attached by the screen printing method (no adhesive film)
- All-round green printing

OPTIONS /ACCESSORIES

- Degree of protection: IP54 (except pendant) – Deviating dimensions: Increase of approx. 4 mm in the width and 7 mm in the height

W35W WALL MOUNTED

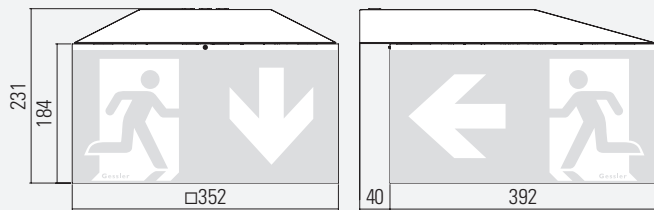

W35D CEILING MOUNTED

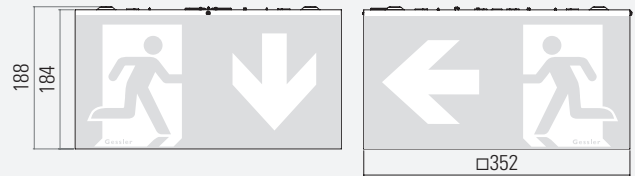

W35P PENDANT

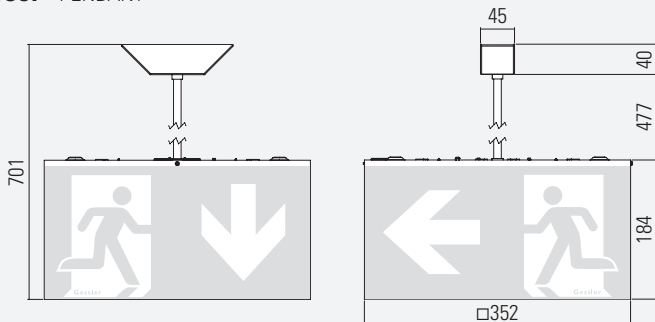

W35S SUSPENDED

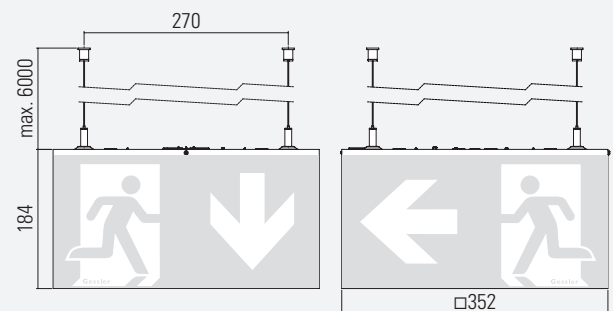

W35Ö EYE INSTALLATION

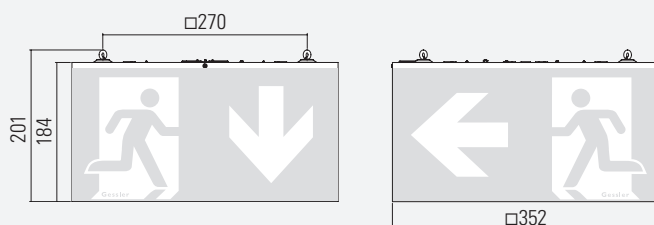

W35

EXIT SIGN CUBE W60

SYSTEM LUMINAIRE

Viewing distance	60 m
Degree of protection	IP54
Class	I
Enclosure material	Acrylic glass
Enclosure colour/surface	opal
Terminal block	3 x 2.5 [□] for through wiring
Light source	LED
Ambient temperature	-20° C to +40° C
Connected load (AC/DC)	172 VA/14.7 W
Supply voltage	230V ± 10 %, 50/60 Hz/176-275 V DC
Rechargeable battery	

VERSION

1 h with auto-check BUS check	
3 h with auto check BUS check	
8 h with auto check BUS check	
without monitoring	•
with monitoring	•
DALI monitoring	•
Cinema version	

SPECIAL FEATURE

- Pictograms are attached by the screen printing method (no adhesive film)
- All-round green printing

W60D CEILING MOUNTED



W60S SUSPENDED

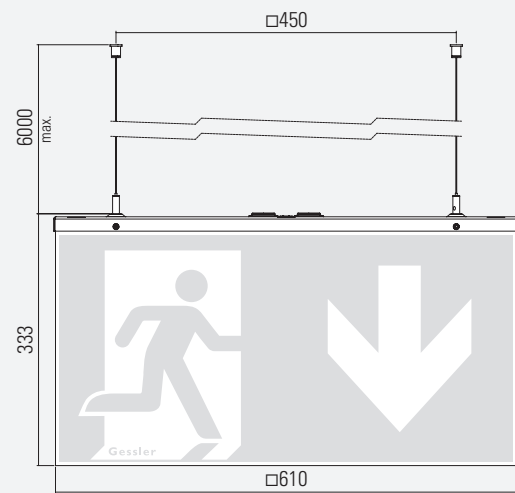

W60Ö EYE INSTALLATION

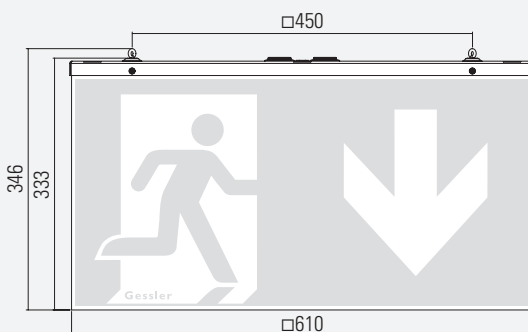

W60